



KEY FEATURES

- Professional LED floodlight to use up to 14 meters
- Special asymmetric lens with 0% LOR
- Integrated LED driver
- Uniform light distribution
- Included 3-pole IP68 connector
- Included 1.5 meter cable
- IK08 Vandal-proof / Impact-resistant Aluminum housing and glass cover
- Angle mounting (45°) and tilting up to 180°
- Long service life of 76,000 hour (L80B10) 50,000 (L90B50)
- Suitable for use temperatures: -30 to + 50 ° C
- Installation on wall and/or pole (accessories needed-not included)
- 5 year Pragmalux Warranty

IP66 IK08 650°GWT 133LM/W 55x110°

5 PRAGMALUX
YEAR
WARRANTY

7 PRAGMALUX
YEAR
WARRANTY
EXTENDED-PRO

DETAILS



Back



Pole adaptor

OPTIONS

1 HOUR 3 HOUR SENSOR RF/PIR 3000K 5000K

ACCESSORIES



Protection Mesh
50W - 4605463



Protection Mesh
100W - 4605470



Protection Mesh
150W - 4605487



Protection Mesh
200W - 4605494



Protection Mesh
300W - 4605500



Pole adaptor Ø42
4605432



Pole adaptor Ø60
4605449



Pole adaptor Ø72
4605456



2 Flood Base
10000268

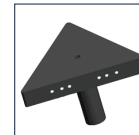

3 Flood Base
10000251

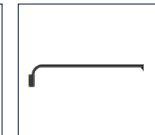

Arm 1 meter
10000275

SPECIFICATIONS

| ITEM CODE | DESCRIPTION | W | LM | LM/W | KELVIN | CRI | INPUT CURRENT | LIFETIME L80B10 | EQUIVALENT | BEAM ANGLE |
|-----------|--|-----|-------|------|--------|-----|---------------|-----------------|------------|------------|
| 4605388 | LED Floodlight Auva IP66 50W 4000K Asymmetrical | 50 | 6600 | 132 | 4000 | ≥80 | 0.25 | 76000 | 100W | 55x110° |
| 4605395 | LED Floodlight Auva IP66 100W 4000K Asymmetrical | 100 | 12900 | 129 | 4000 | ≥80 | 0.5 | 76000 | 150W | 55x110° |
| 4605401 | LED Floodlight Auva IP66 150W 4000K Asymmetrical | 150 | 19900 | 133 | 4000 | ≥80 | 0.73 | 76000 | 250W | 55x110° |
| 4605418 | LED Floodlight Auva IP66 200W 4000K Asymmetrical | 200 | 26400 | 132 | 4000 | ≥80 | 0.98 | 76000 | 400W | 55x110° |
| 4605425 | LED Floodlight Auva IP66 300W 4000K Asymmetrical | 300 | 40000 | 133 | 4000 | ≥80 | 1.45 | 76000 | 800W | 55x110° |

TECHNICAL DATA

ELECTRICAL DATA

| | |
|---------------------------|--------------------------------|
| Voltage (V) | 220-240 |
| Frequency (Hz) | 50/60 |
| Power factor (λ) | ≥0.9 |
| Operating mode | Integrated LED Driver |
| Electrical connection | Max 3x105 mm ² wire |
| Total harmonic distortion | ≤ 20 % |

TEMPERATURES & OPERATING CONDITIONS

| | |
|-----------------------|-------------|
| Ambient temperature | 25°C |
| Operating temperature | -30 ~ +50°C |
| Storage temperature | -40 ~ +85°C |

COLORS & MATERIALS

| | |
|-----------------------|----------------|
| Color (Housing) | Black RAL9017 |
| Material (Housing) | Aluminum |
| Material (Reflector) | Tempered glass |

CERTIFICATES & STANDARDS

| | |
|--------------------------------------|------------------|
| Driver certificates | CE |
| Fixture certificates | CE / ENEC |
| Ingress protection | IP66 |
| Protection class | I |
| Protection class IK | 08 |
| Glow Wire Test (IEC 695-2-1) | 650°C |
| Photobiological safety group EN62778 | RG1 |
| IEC | EN IEC 62722-2-1 |
| LM80 (TM21) L90B50 (hours) | >50,000 |

CAPABILITIES

| | |
|-----------------------|-------------------------------------|
| UGR | ≤25-30 |
| Dimmable | No / 1-10V Dimming |
| Type of connection | Push Terminal, 3-pole |
| LED Module replacable | No |
| Installation | Wall-Surface mounted / Pole mounted |

PRAGMALUX

All rights reserved. Pragmalux - PDL Lighting Group B.V. retains the right to modify product specifications without any prior notice or obligation and does not assume any liability for any consequences of using this document. Subject to errors and printing errors. Luminous flux tolerance: +/- 10%. Power consumption tolerance: +/- 10%.

Version: February 2021

| ITEM CODE | DESCRIPTION | DRIVER FAILURE RATE AT 5,000H | INRUSH CURRENT IPEAK (A) | INRUSH CURRENT TWIDTH (µs) | MAX. NO. OF DRIVERS ON MCB TYPE B 10A | MAX. NO. OF DRIVERS ON MCB TYPE B 16A | MAX. NO. OF DRIVERS ON MCB TYPE C 10A | MAX. NO. OF DRIVERS ON MCB TYPE C 16A |
|-----------|--|-------------------------------|--------------------------|----------------------------|---------------------------------------|---------------------------------------|---------------------------------------|---------------------------------------|
| 4605388 | LED Floodlight Auva IP66 50W 4000K Asymmetrical | ≤1% | 60 | 450 | 5 | 9 | 10 | 16 |
| 4605395 | LED Floodlight Auva IP66 100W 4000K Asymmetrical | ≤1% | 60 | 450 | 2 | 4 | 4 | 8 |
| 4605401 | LED Floodlight Auva IP66 150W 4000K Asymmetrical | ≤1% | 60 | 650 | 2 | 4 | 4 | 7 |
| 4605418 | LED Floodlight Auva IP66 200W 4000K Asymmetrical | ≤1% | 60 | 650 | 2 | 4 | 4 | 7 |
| 4605425 | LED Floodlight Auva IP66 300W 4000K Asymmetrical | ≤1% | 80 | 650 | 1 | 2 | 2 | 2 |

DIMENSIONS

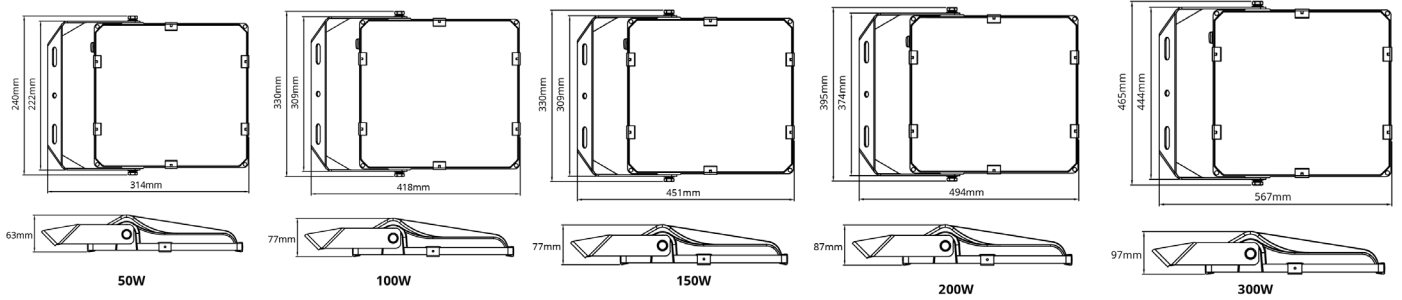

PHOTOMETRIC SPECIFICATIONS

LED FLOODLIGHT AUVA 50W 4000K

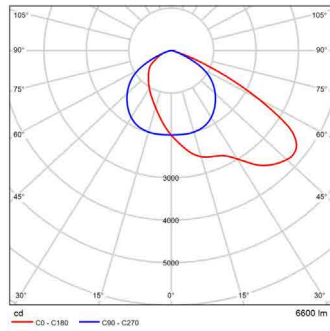

LED FLOODLIGHT AUVA 100W 4000K

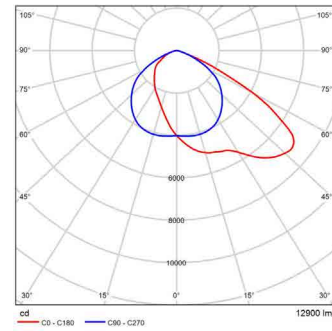

LED FLOODLIGHT AUVA 150W 4000K

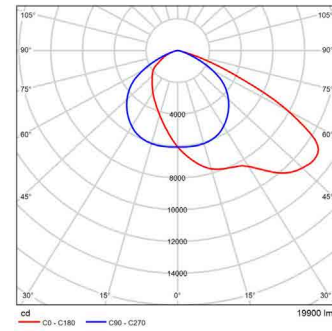

LED FLOODLIGHT AUVA 200W 4000K

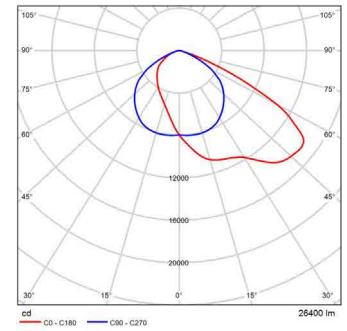

LED FLOODLIGHT AUVA 300W 4000K

